

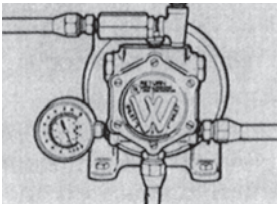
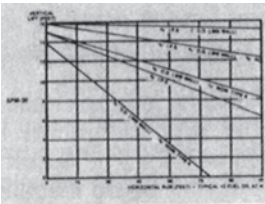
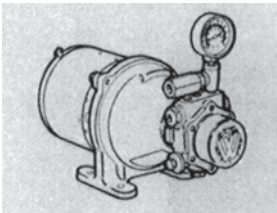
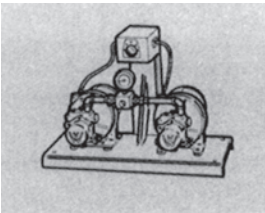

Installation and Operating Instructions

SPM Series Pump/Motor Units

BULLETIN INDEX

		Section	Information	Page
		Section One:	Locating Units	2
			General Installation Information	Filter or Strainer
Correct Suction Line Size	2-3			
Measuring Inlet Vacuum	4			
Oil Safety Valves	4			
Entrapment Caution	4			
Combination Gas-Oil Furnaces	4			
Distribution Piping	4			
		Section Two:	Specifications	5
SPM Single and Duplex Manual Models	Tank to Pump Connections	5		
	Pressure Sensing Switches	6		
	Correct Discharge Line Size	6-7		
	Multi-level Supply Systems	7		
	Open Loop Supply Systems	8		
	Electrical Connections	8		
	Setting Pump Pressure	8-9		
	Typical Installation Diagrams	9		
		Section Three:	Specifications	10
SPM Duplex Automatic Models	Tank to Pump Connections	10		
	Typical Installation Diagrams	11		
	Automatic Control Action	11-12		
	Correct Discharge Line Size	12-13		
	Electrical Connections	14		
	Setting Pump Pressure	14		
		Section Four:	Installation Checklist	17

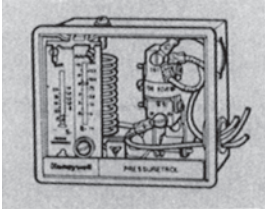
USING THIS BULLETIN

This bulletin contains installation and operating instructions for the complete line of Webster SPM Series Pump/Motor Units. Since each supply system is different, these instructions should serve only as a general guide to installation. For specific problems relating to your application, please contact the Webster sales department or your local Webster representative. Compliance to all applicable codes where installed is the sole responsibility of the installer.

Before beginning installation, it is important to carefully read *Section One: General Information*. Then refer to the appropriate section for the specific SPM model being installed. A helpful *Installation Checklist* is included on page 15.

SPM SERIES FEATURES

SPM Series Pump/Motor Units consist of a fuel pump direct coupled to a motor, an integral check valve and combination vacuum/pressure gage. They are designed to supply fuel oil from a central storage tank to remote heating units or auxiliary tanks.

The SPM Duplex models consist of two pump/motor assemblies with a pre-piped, common discharge manifold. One pump/motor unit operates continuously, with the second providing backup service if the main pump fails. Either automatic (SPM-DA models) or manual (SPM-DM models) controls are available.

For further SPM Series specifications, see Webster Bulletin FU41-g.

Webster® Fuel Pumps & Valves

Section One: General Information

LOCATING UNITS

Install SPM Units in a clean, dry, well-ventilated location as close to the storage tank as possible. Close installation will minimize required vacuum and will allow smallest diameter piping to be used while assuring an adequate supply of oil.

The units can be mounted in any position. Preferred position for convenient line connections is horizontal, with foot mounts down.

FILTER OR STRAINER

A reliable in-line filter or strainer is recommended between the tank and the supply pump. Filter or strainer capacity must at least equal the suction gear

capacity of the pump to minimize restriction in the suction line. For suction capacity refer to *Design Data*: SPM Single or Duplex models, page 5; SPM Duplex Automatic models, page 10.

CORRECT SUCTION LINE SIZE

Correct sizing of the suction line between the storage tank and supply pump is vital. Use of tubing or pipe which is too small can result in restricted oil supply.

The charts below can help determine suggested minimum suction line size for recommended two pipe operation. Refer to the correct chart for the particular size SPM unit being installed. These charts apply to all SPM Single, Duplex Manual and Duplex Automatic models.

SPM-15

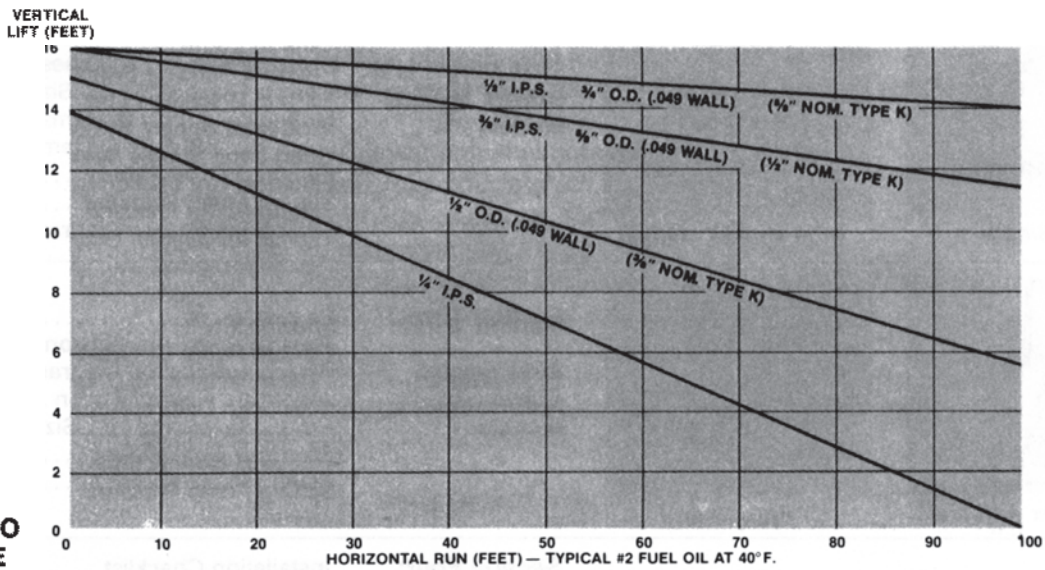

RECOMMENDED SUCTION LINE SIZE

SPM-30

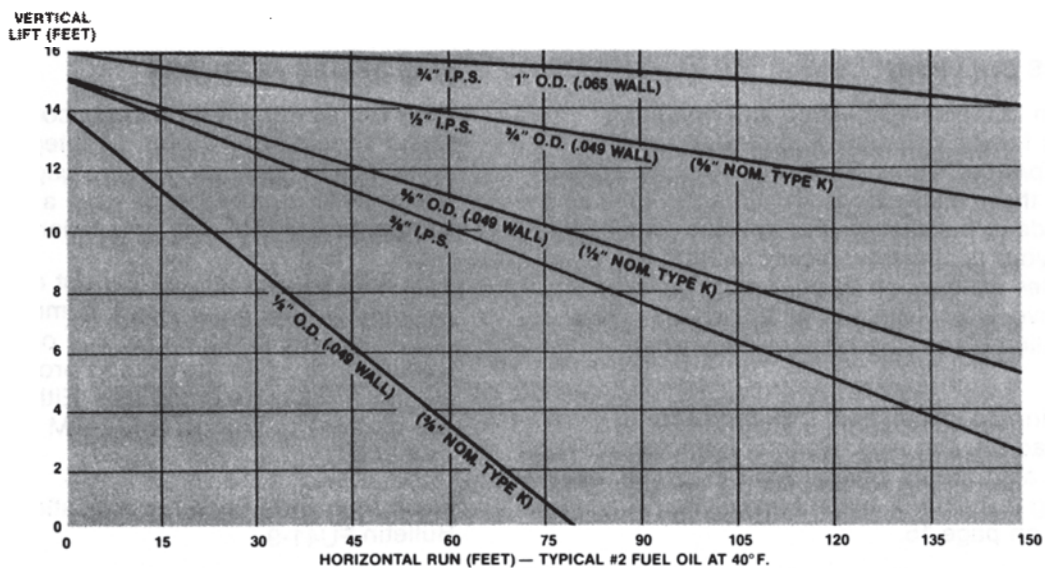

Charts represent maximum horizontal run vs. vertical lift for Standard Schedule 40 iron or steel pipe (I.P.S.) and for Type K copper tubing, recommended for underground service. The actual O.D. and wall thickness are indicated for each tube size. (Note: The nominal size of Type K tubing is 1/8 inch smaller than actual O.D.)

Determine *Length of Horizontal Run - Feet*, and read up to *Vertical Lift - Feet* for your specific application. This point determines the minimum diameter copper tubing or Schedule 40 standard pipe that can be used while still assuring an adequate supply of oil. Use the pipe or tube size whose straight line passes above and closest to the intersection point.

Important: You should account for any added restrictions in the suction line, such as filters, strainers, check valves, elbows. These restrictions add to frictional losses and increase required vacuum. Also, charts are based on use of #2 fuel oil at 40°F. Larger line sizes may be necessary if oil is heavier than #2, or if system is exposed to colder temperatures. When in doubt, use the next larger tube or pipe size.

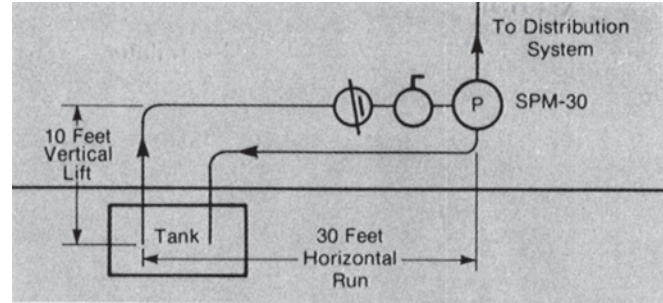

Example: System shown requires SPM-30, has 10 feet vertical lift and 30 feet horizontal run. Refer to chart for SPM-30 and read up from 30 feet horizontal run, to 10 feet vertical lift. The closest lines that pass above this point are for 3/8 inch I.P.S. standard pipe; 5/8 inch O.D. copper tubing; or 1/2 inch Nom. Type K.

SPM-65

RECOMMENDED
SUCTION LINE
SIZE

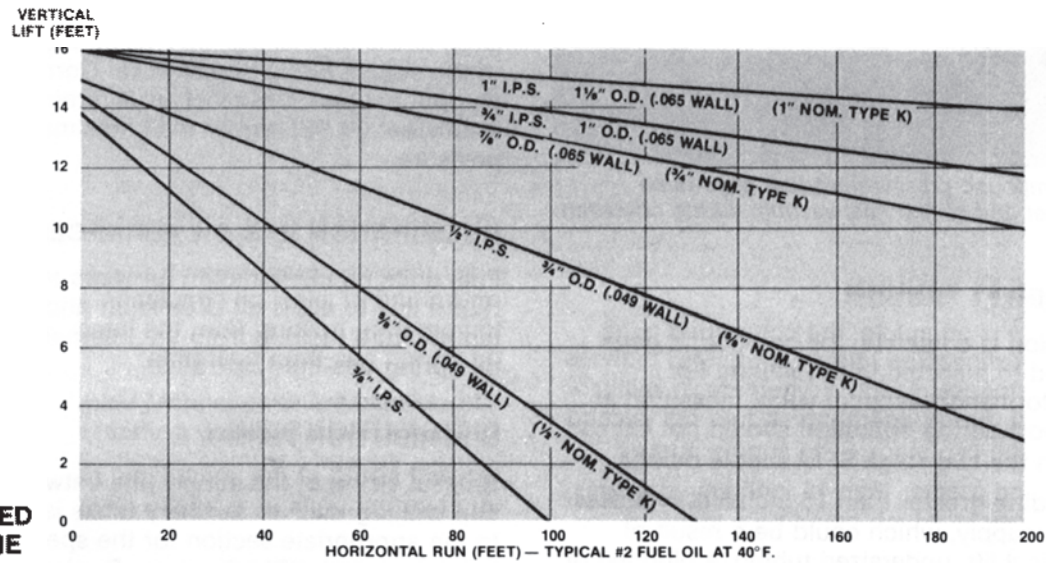

SPM-135

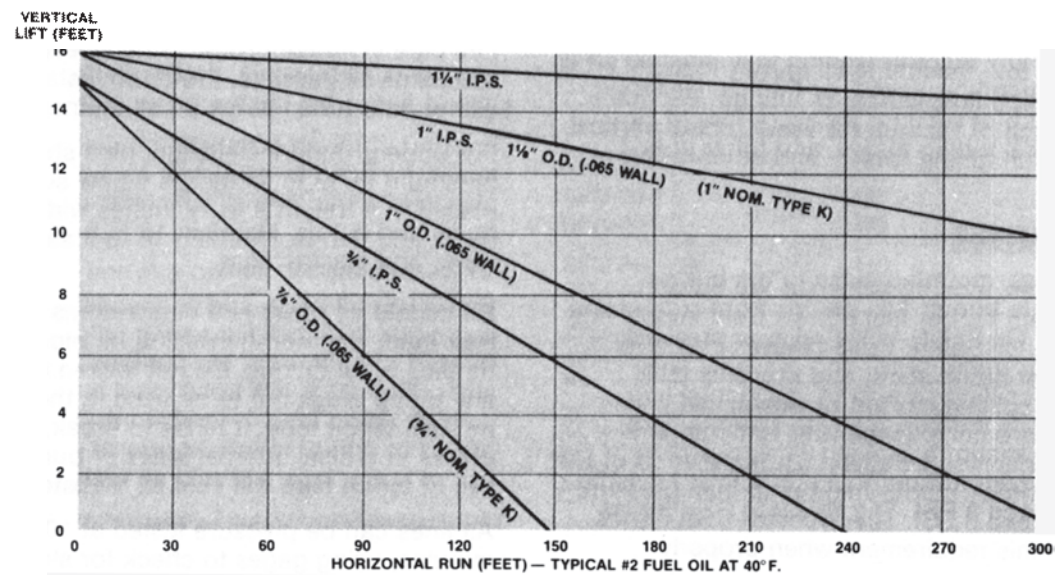

Charts represent maximum horizontal run vs. vertical lift for Standard Schedule 40 iron or steel pipe (I.P.S.) and for Type K copper tubing, recommended for underground service. The actual O.D. and wall thickness are indicated for each tube size. (Note: The nominal size of Type K tubing is 1/8 inch smaller than actual O.D.)

General Information – continued

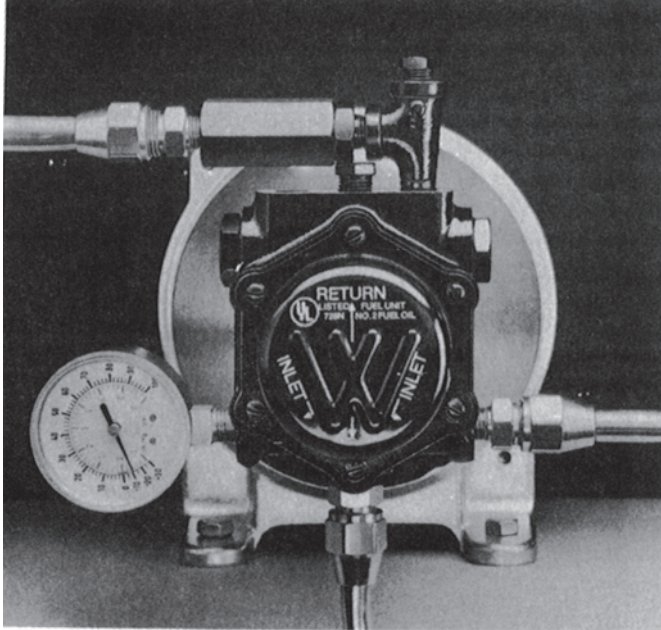

Connect the compound pressure/vacuum gage to an unused SPM inlet port to test inlet vacuum during operation.

MEASURING INLET VACUUM

When installation is complete, the compound gage should be used to measure inlet vacuum. For maximum performance, vacuum when measured at unused inlet port during operation should not exceed 15 inch Hg. on the two stage SPM supply pumps.

A vacuum reading greater than 15 inch Hg. indicates inadequate oil supply, which could be a result of excessive vertical lift, undersized tubing, a plugged or undersized filter or strainer, sticking check valves, or a frozen, kinked or otherwise restricted suction line.

An abnormally low vacuum reading may indicate an air leak in the suction line, valves, or fittings. Generally, assume 0.75 inch of vacuum for every foot of vertical lift, plus frictional tubing losses, and other in-line restrictions.

OIL SAFETY VALVES

Oil Safety Valves, mounted close to the burner assembly, isolate burner fuel pumps from supply line pressures. The Oil Safety Valve relieves pressure strain on burner pump seals, and prevents tank siphoning and spilling caused by accidental line breaks. To assure compliance with National Fire Protection Association's Bulletin 31, *Installation of Oil Burning Equipment*, burner fuel pump inlet pressure should not exceed 3 PSI. The Webster OSV Series Valves satisfy this requirement when properly installed.

An optional mesh strainer, rated for maintained system pressure, can be installed before each OSV.

near the burner assembly to protect the OSV from harmful scale which may occur in black iron pipe.

Tee fittings should also be inserted on the supply side of each OSV in the system. This will allow a pressure reading to be taken when setting system pressure.

ENTRAPMENT CAUTION

In supply systems having a check valve on the supply pump discharge, an entrapment condition may exist between the supply pump and the OSV. Cold oil in the supply line in the burner OFF-mode expands on heating from room temperature, causing a line pressure rise that may prevent the OSV from operating.

This condition may be observed by use of a pressure gage at the inlet of the OSV or on the discharge side of the supply pump check valve. Correction requires an optional pressure relief valve, drained to tank return, set 20 PSI higher than maximum operating pressure.

COMBINATION GAS-OIL FURNACES

Fuel units on combination furnaces must have a return line to allow oil circulation and prevent temperature buildup from the internal re-circulation of oil during gas-fired operation.

DISTRIBUTION PIPING

Correct sizing of the supply line between SPM units and heating units or auxiliary tanks is essential. Refer to the appropriate section for the specific SPM model being installed: SPM Single or Duplex Manual models, page 6; SPM Duplex Automatic models, page 12.

Lay pipe in straight runs, using sweep elbows, with as few joints as possible. Preferred installation calls for use of flare tube fittings on all connections.

For underground installation, pipe should be buried a minimum of 18 to 24 inches below surface grade, placed in a trench 9 to 12 inches wide cleared of all rocks and debris. Maintain 10 foot separation from water and electric lines.

Be certain all plugs and connections are secure and leak-tight. Use non-hardening oil pipe dope on threads of all fittings. Do not loosen or try to tighten any pump plugs not to be used in the installation. **Do not use teflon tape.** It tends to break, depositing small pieces in critical internal areas of pump. **Therefore, use of teflon tape will void all Webster warranties.**

All lines can be pressure tested at 100 PSI for 60 minutes, using gages to check for slow leaks. Connections and fittings can be swabbed with soap water and observed for pin-hole leaks. After correcting any leaks, fill trenches with trash free dirt.

Section Two: SPM Single and SPM Duplex Manual Models

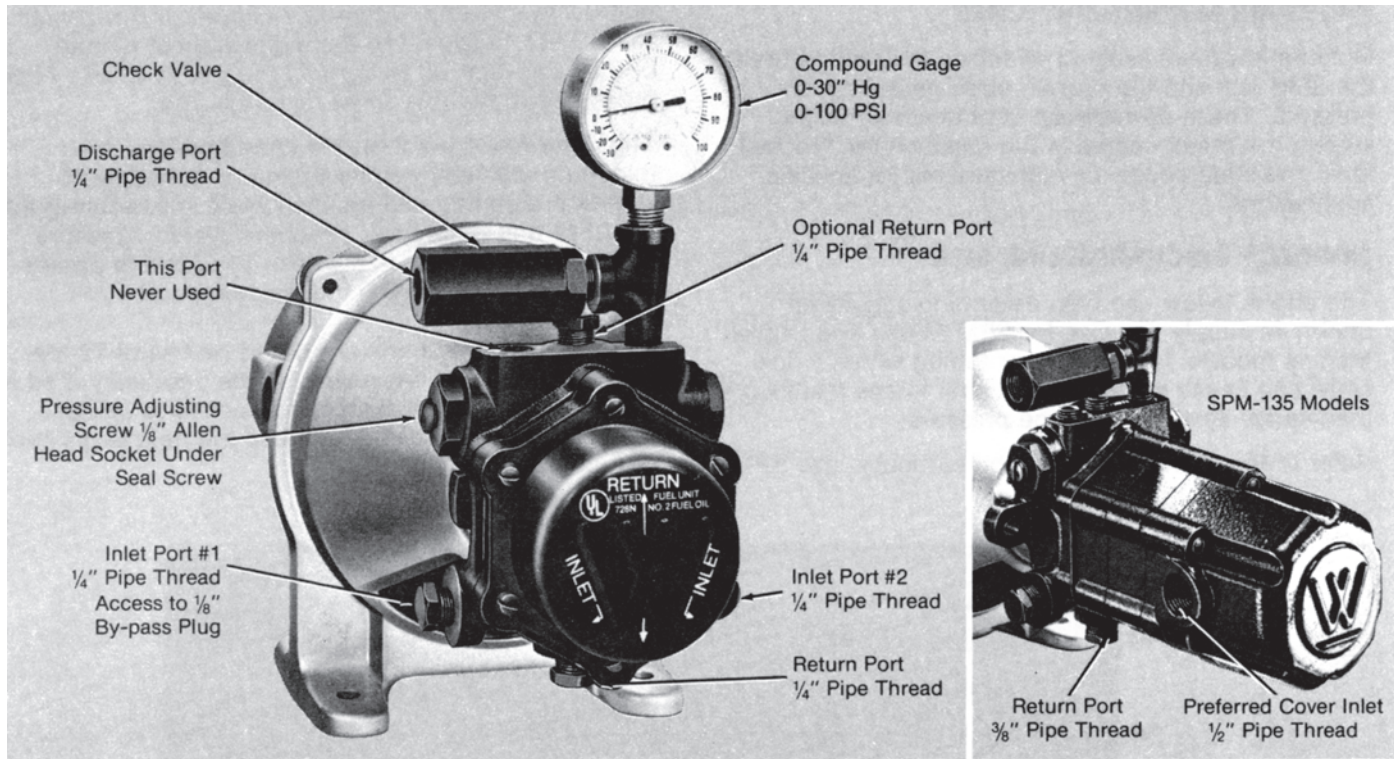

SPECIFICATIONS

SPM Single and Duplex Manual units are capable of supplying fuel oil to heating units or tanks located up to 200 feet above the supply pumps. They are designed for use in maintained pressure or open loop systems. Pump pressures can be set at a range from 20 PSI to 85 PSI. See *Correct Supply Line Size* charts, on page 6, for maximum discharge head.

TANK TO PUMP CONNECTIONS

Connect suction line from the tank to preferred supply pump inlet port. Connect return line from pump return port to tank. Internal $\frac{1}{8}$ " by-pass plug (factory installed) must be in position for recommended two pipe operation. **Be certain all plugs and connections are secure and leak tight.**

The correct suction line size can be determined by referring to the charts on page 2. Generally, the return line should be sized the same as the suction line. Check valves in the suction lines between the tank and SPM units assure that pumps are full of oil, ready for service. Check valves must be oil tight. Low pressure drop swing type are recommended to minimize friction loss.

For SPM Duplex Manual models, preferred installation calls for a separate suction line from tank to pump for each pump/motor unit. If system failure occurs because of a gross leak in the suction line of the primary unit, the second unit can still provide backup

service. Check valves can be installed in return lines to allow removal of inactive pump for servicing, while primary pump continues to run.

DESIGN DATA

Model	Type	Volt- age	Motor H.P.	Max. Total Firing Rate GPH*	Suction Capacity GPH
SPM-15-1	Single	115	$\frac{1}{8}$	15	35
SPM-15-2		230			
SPM-15-1-DM	Duplex Manual	115	$\frac{1}{8}$	15	35
SPM-15-2-DM		230			
SPM-30-1	Single	115	$\frac{1}{4}$	30	70
SPM-30-2		230			
SPM-30-1-DM	Duplex Manual	115	$\frac{1}{4}$	30	70
SPM-30-2-DM		230			
SPM-65-1	Single	115	$\frac{1}{2}$	65	125
SPM-65-2		230			
SPM-65-1-DM	Duplex Manual	115	$\frac{1}{2}$	65	125
SPM-65-2-DM		230			
SPM-135	Single	Dual	$\frac{1}{2}$	135	250
SPM-135-DM	Duplex Manual	Dual	$\frac{1}{2}$	135	250

*Total firing rate is equal to the sum of burner firing rates, when burners are set for one-pipe operation as recommended. Total must not exceed maximum rating shown.

SPM Single and SPM Duplex Manual Models – continued

PRESSURE SENSING SWITCHES

Optional pressure sensing switches, installed between the SPM unit and the burner, open on a drop in pressure. These devices can shut down a heating system if a break occurs in the supply lines. Consult local and state codes for requirements for specific applications.

CORRECT DISCHARGE LINE SIZE

The charts below can help determine suggested minimum supply line size for SPM Single and Duplex Manual models. Use of pipe or tubing which is too small can cause increased frictional losses resulting in inadequate system discharge pressure.

Refer to the correct chart for the particular size SPM

unit being installed. Determine *Length of Horizontal Run - Feet* measured to the highest, most remote burner and read up to *Vertical Discharge Head - Feet* measured to highest, most remote burner.

The determined point on the chart indicates the minimum diameter copper tubing or Schedule 40 standard pipe that can be used while still assuring that the SPM unit will deliver adequate system pressure. Use the pipe or tube size whose straight line passes above and closest to the intersection point.

Important: These charts are based on use of #2 fuel oil at 40°F. Larger line sizes may be necessary if oil is heavier than #2, or if system is exposed to colder temperatures. When in doubt, use the next larger tube or pipe size.

SPM-15

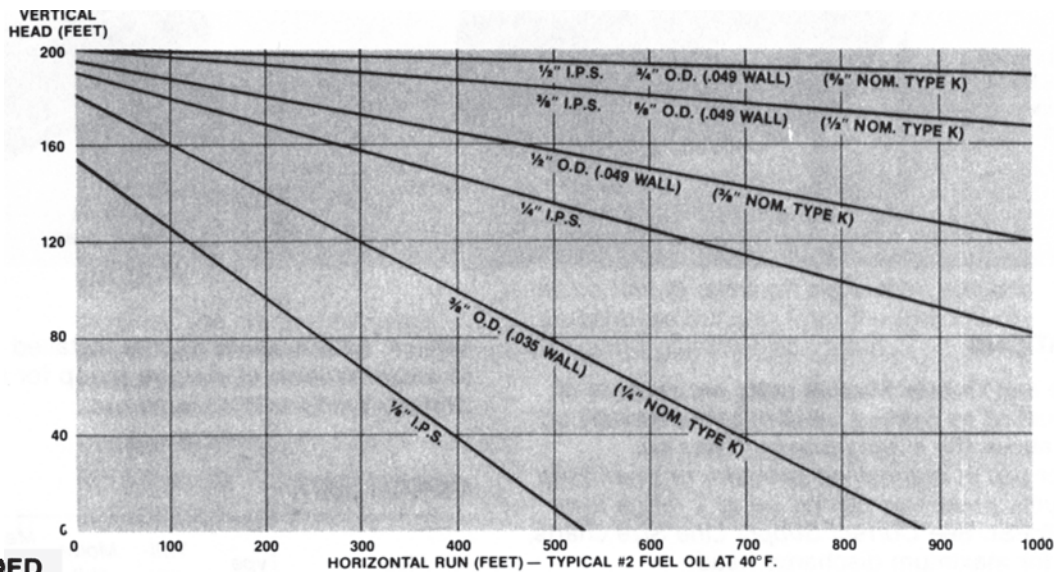

RECOMMENDED DISCHARGE LINE SIZE

SPM-30

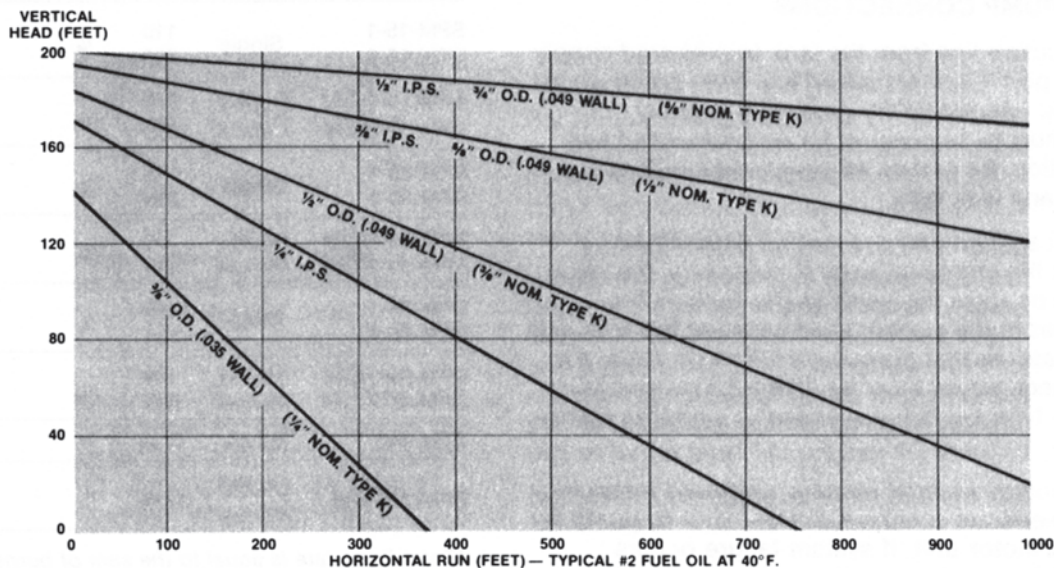

Charts represent maximum horizontal run vs. vertical head for Standard Schedule 40 iron or steel pipe (I.P.S.) and for Type K copper tubing, recommended for underground service. The actual O.D. and wall thickness are indicated for each tube size. (Note: The nominal size of Type K tubing is 1/8 inch smaller than actual O.D.)

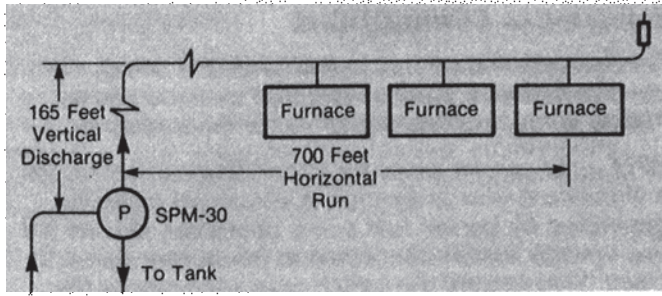

Example: System shown requires SPM-30, has 165 feet vertical discharge head and 700 feet horizontal run. Refer to chart for SPM-30 and read up from 700 feet horizontal run to 165 feet vertical head. The closest lines that pass above this point are for 1/2 inch I.P.S. standard pipe; 3/4 inch O.D. copper tubing; 5/8 inch Nom. Type K.

MULTI-LEVEL SUPPLY SYSTEMS

In supply systems with heating units on different levels, special care must be taken when sizing supply lines, since the inlet pressure on the OSV valve must not exceed maximum valve operating pressure of 60 PSI. See *Installation Diagram*, page 9. Generally, the lowest OSV valve in the system receives the highest pressure.

To assure that pressure at the lowest OSV does not exceed the maximum valve operating pressure of 60 PSI, observe the following rules: 1) Vertical distance between the lowest OSV and the highest point in the piping must not exceed 100 feet; 2) If the vertical distance is greater than 60 feet, the supply line should be one size larger than suggested.

SPM-65

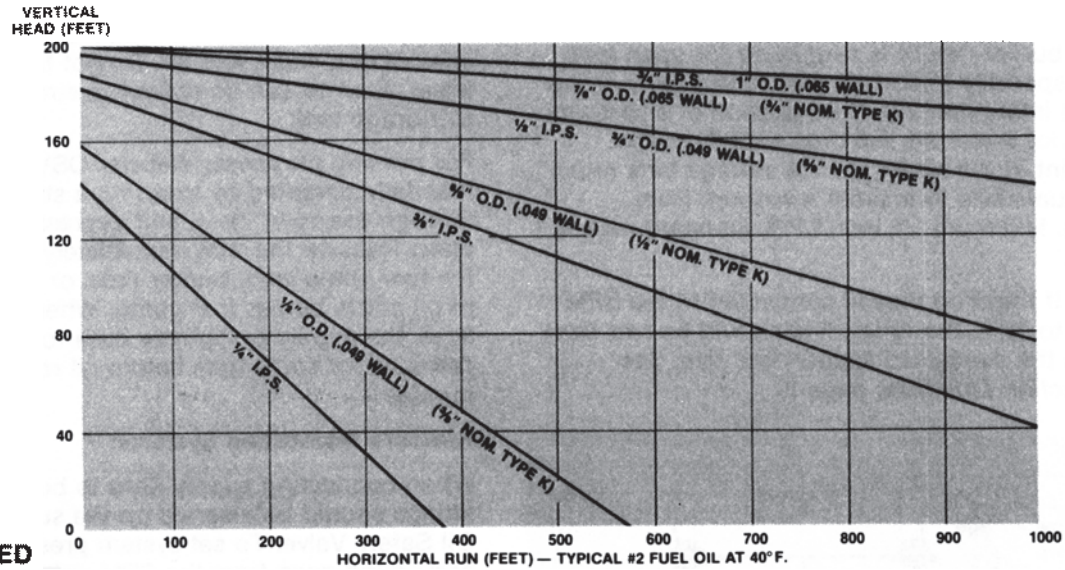

RECOMMENDED DISCHARGE LINE SIZE

SPM-135

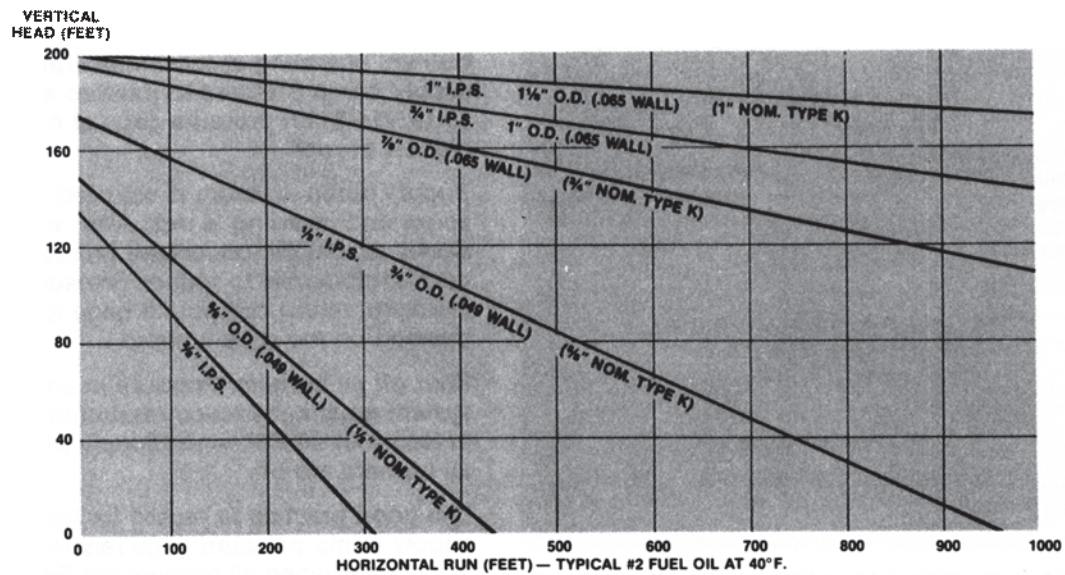

Charts represent maximum horizontal run vs. vertical head for Standard Schedule 40 iron or steel pipe (I.P.S.) and for Type K copper tubing, recommended for underground service. The actual O.D. and wall thickness are indicated for each tube size. (Note: The nominal size of Type K tubing is 1/8 inch smaller than actual O.D.)

SPM Single and SPM Duplex Manual Models – continued

OPEN LOOP SUPPLY SYSTEMS

To insure a flooded supply line, a standpipe or back pressure valve is required before the junction of the supply line with the return line.

The standpipe should be at least two to four feet higher than any point in the supply line system before joining the return line. If necessary, Oil Safety Valves should be mounted close to each burner pump to assure that inlet pressures do not exceed 3 PSI when all burners are off.

When a back pressure valve is used, it should be set to provide about 5 to 10 PSI at highest burner in the system, with all burners firing. Oil Safety Valves should be used to protect burner pump seals from system pressure.

Installation of a #48598 vacuum breaker in the return line above burner height is suggested for open loop systems (especially important when the supply pump is operated intermittently). If installation of a vacuum breaker is not preferred, the drop pipe from the highest point in the system to the storage tank must be of adequate size to prevent a vacuum from developing. Minimum 1¼ inch I.P.S. standard pipe is suggested.

Important: If the drop pipe is connected to the SPM return line to tank, the return line should be two sizes larger than the suggested suction line size. See *Correct Suction Line Size*, page 2.

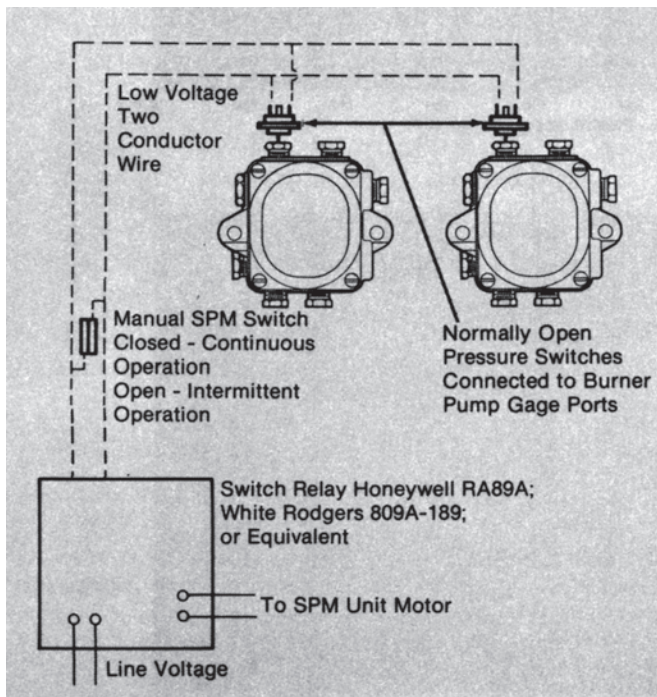

When wired for intermittent operation, switch relay activates the SPM unit which starts and stops automatically with the burner.

ELECTRICAL CONNECTIONS

Connect electric service to the SPM unit using conduit and wire sizes as required by local codes. Follow wiring instructions of motor manufacturer.

SPM units can be wired for intermittent operation for a significant energy savings. A sustained pressure generated by burner fuel pump operation, causes the low-voltage switch connected to the burner pump to close. This causes the switch relays to activate the SPM unit, which starts and stops automatically with the burner. See wiring diagram below.

SETTING PUMP PRESSURE

Initial Startup:

Start pump and flush main distribution lines to clean lines of dirt, water and air. Do not flush system with water. Fuel oil can be collected, strained and returned to storage tank.

For priming purposes, Webster OSV valves can be manually operated by inserting a stiff wire (paper clip) through the cover hole, and depressing the diaphragm plate. Remove the wire immediately if oil appears at the fuel pump vent, burner fires, or there is any sign of oil at the burner fuel pump. When purging long lines, the supply pump may have to run at zero pressure for some time before oil reaches the burner pumps.

Pressure Maintained Systems:

When connecting supply lines to burner pumps, tee fittings should be inserted on the supply side of each Oil Safety Valve. To set system pressure, remove compound gage from the SPM unit discharge port and install in tee fitting in supply line of highest or most remote burner. Start supply pump, and with all burners operating at maximum firing rate, adjust supply pump pressure to develop a positive reading of 10 to 15 PSI on pressure gage at most remote or highest burner.

Supply pump pressure is adjusted by removing cover screw and inserting ⅛ inch Allen wrench. Turn wrench slowly clockwise to increase pressure, counterclockwise to reduce pressure. After adjusting pressure, return compound gage to the original position on the supply pump.

Shut off all burners. Pressure at any OSV valve in system must not exceed maximum valve operating pressure of 60 PSI, when supply pump is running and all burners are off.

It is good practice to record for future reference the supply pump pressure gage readings when all burners are off and when all burners are firing. If the supply pump setting is changed or the pump replaced, the system pressure can more easily be reset.

Open Loop Systems:

Supply pump pressure should be set to supply oil to highest part of system. If a standpipe is used, pressure must be great enough to flow over standpipe to return loop. If a back pressure valve is used, supply pump pressure must be great enough to overcome system head plus preset pressure of valve.

Set supply pump pressure with all burners off.
Remove cover screw, insert 1/8 inch Allen wrench and

turn slowly clockwise to increase pressure. When pressure reading on gage at supply pump outlet stops increasing, turn adjusting screw one additional turn.

Important: If pressure reading on gage seems too great for height of system, check for line restrictions or excessive setting on back pressure valve. Generally, assume 0.38 PSI pressure for every foot of vertical discharge head, plus frictional tubing and fitting losses.

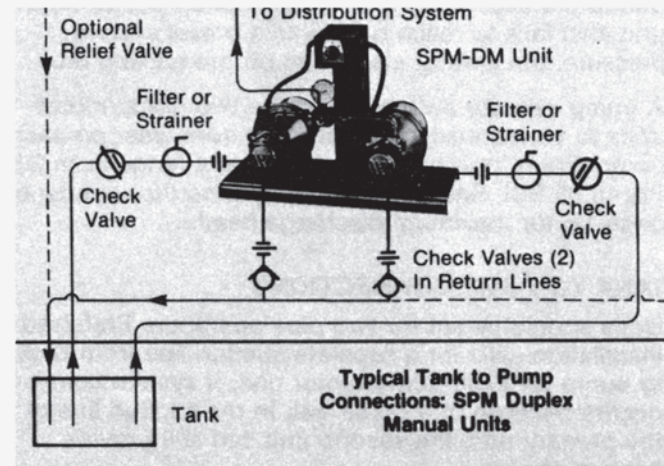
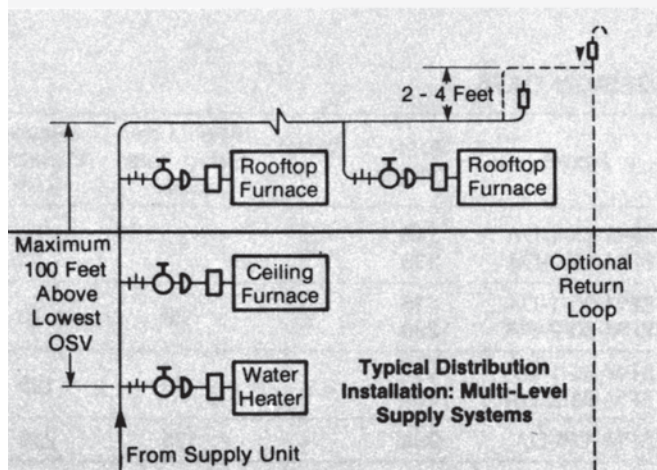
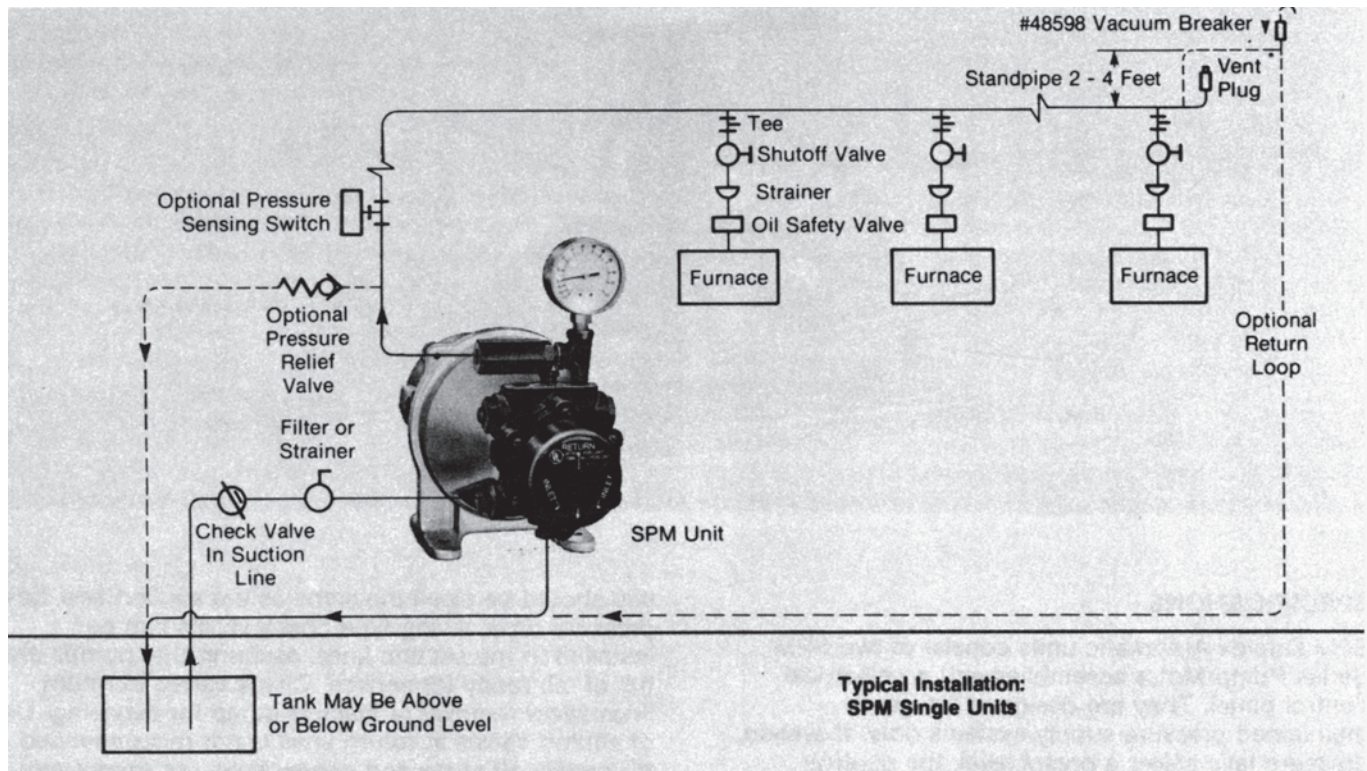

These typical installation diagrams, illustrating a maintained pressure supply system or optional open loop system, for continuous pump operation, are shown for reference only. Compliance to all applicable codes where installed is the sole responsibility of the installer.

Section Three: SPM Duplex Automatic Models

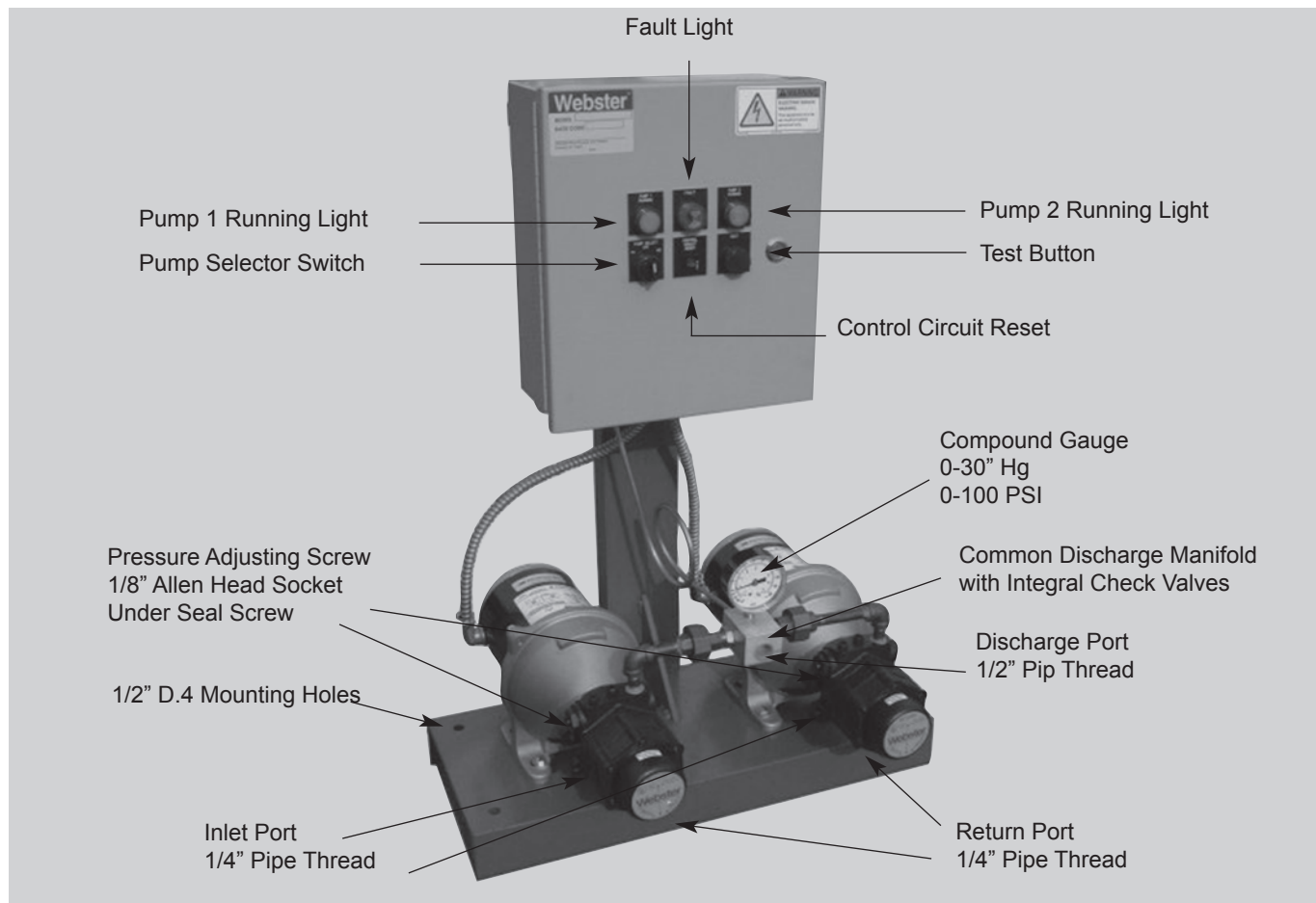

SPECIFICATIONS

SPM Duplex Automatic units consist of two SPM Series Pump/Motor assemblies and an electrical control panel. They are designed for use in maintained pressure supply systems *only*. If system pressure falls below a preset level, the control automatically switches from the primary pump/motor unit to the secondary unit. If the backup pump/motor unit also fails to reach or maintain preset system pressure, the control also shuts off the backup unit.

A pump selector switch allows the two pump/motor units to be manually alternated for even wear on each pump. Pump pressures can be set at a range from 20 PSI to 85 PSI. See *Correct Supply Line Size* charts, on page 12, for maximum discharge head.

TANK TO PUMP CONNECTIONS

Units should be set for two pipe operation. Preferred installation calls for a separate suction line from tank to pump for each pump/motor unit. If system failure occurs because of a gross leak in the suction line of the primary unit, the second unit can still provide backup service.

The correct suction line size can be determined by referring to the charts on page 2. Generally, the return

line should be sized the same as the suction line. Low pressure drop, swing type check valves can be installed in the suction lines, assuring that pumps are full of oil, ready for service. Check valves in return lines allow removal of inactive pump for servicing. Use of shutoff valves in return lines is not recommended. **Be certain all plugs and connections are secure and leak-tight.**

DESIGN DATA

Model	Motor Voltage	Motor H/P	Max. Total Firing Rate* GPH	Suction Capacity GPH
SPM-15-1-DA	115	1/8	15	35
SPM-15-2-DA	230			
SPM-30-1-DA	115	1/4	30	70
SPM-30-2-DA	230			
SPM-65-1-DA	115	1/3	65	125
SPM-65-2-DA	230			
SPM-135-DA	Dual	1/2	135	250

*Total firing rate is equal to the sum of burner firing rates, when burners are set for one-pipe operation as recommended. Total must not exceed maximum rating shown.

AUTOMATIC CONTROL ACTION

Selector Switch:

The selector switch on the control panel can start either *Pump One* or *Pump Two* as the lead pump. *Pump One* is on the left side, *Pump Two* on the right side of the duplex unit, as viewed from the front.

Initial Startup:

The lead pump must build operating pressure in approximately 15 seconds after startup, or the loss of pressure control sequence will occur, as described below. When purging long lines, the supply pump may have to run at zero pressure for some time before oil reaches the burner pumps. Automatic switching and shutdown can be prevented by adjusting the Pressuretrol main scale indicator to 0 as described in *Setting Pump Pressures*, page 14.

Loss of Supply Pressure:

A drop in pressure below a preset level causes the lead pump to shut down, the lag pump to start, and an alarm buzzer to sound. If the lag pump does not build pressure in approximately 15 seconds, it also shuts down and the alarm continues to sound. If the lag pump does build pressure, the alarm will continue to indicate a malfunction.

To Shut Off Alarm and Reset Unit:

With buzzer on and both pumps shut down: Move selector switch to *off* for approximately 15 seconds (allow timers to reset). To restart, move selector switch to desired pump. With buzzer on, lag pump running and maintaining pressure: Move selector

(continued on next page)

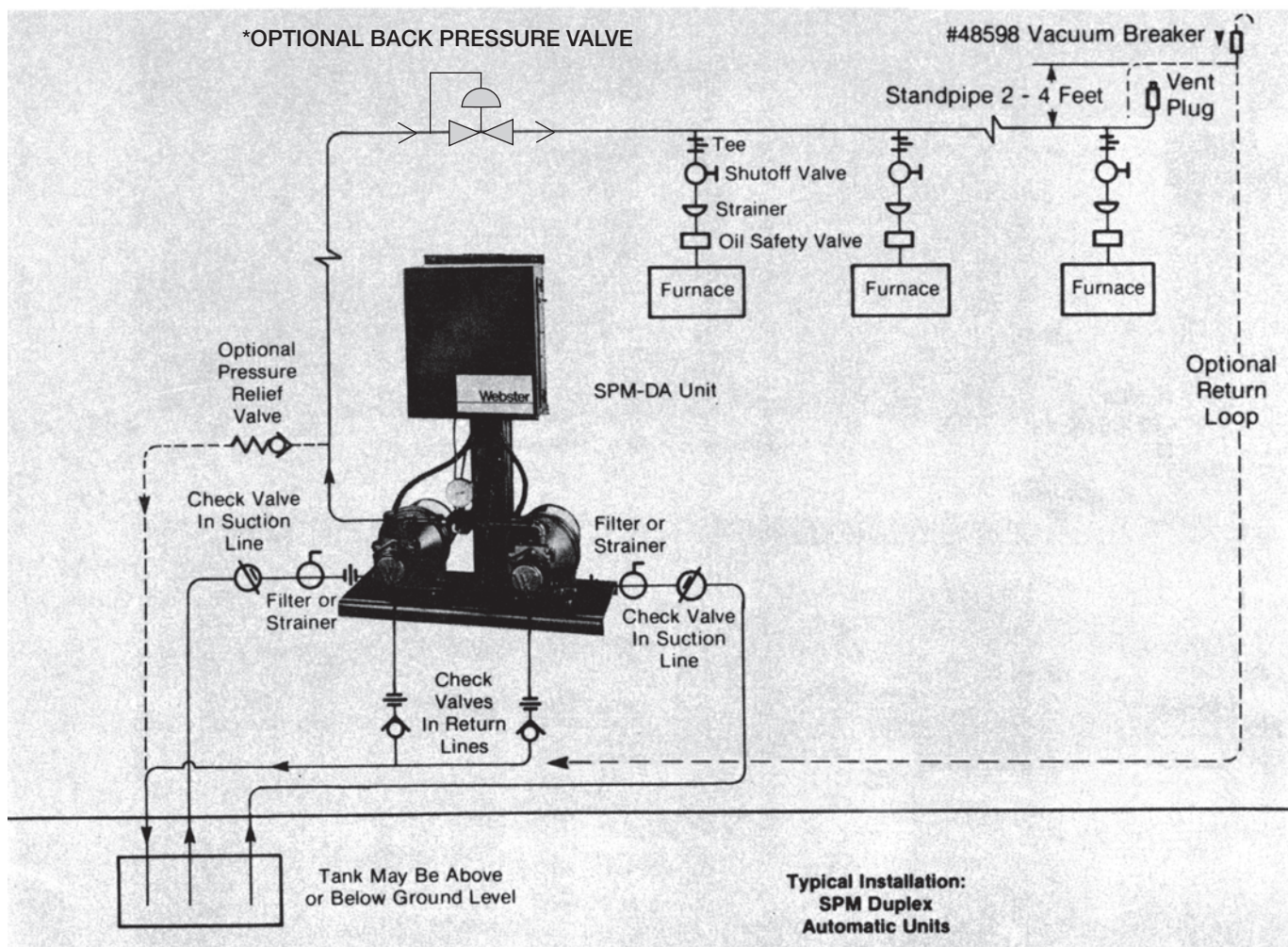

***BACK PRESSURE VALVE IS REQUIRED IN OPEN LOOP SYSTEMS**

This typical installation diagram illustrating a maintained pressure supply system for continuous pump operation is shown for reference only. Compliance to all applicable codes where installed is the sole responsibility of the installer.

SPM Duplex Automatic Models - continued

CONTROL ACTION, continued

switch to *off* momentarily, then to lag pump position. Buzzer will shut off, lag pump will continue running. Note: Moving selector switch from lead to lag position before lag pump has built pressure results in lead pump restarting.

Test Button:

The action of the control panel can be tested while the system is at normal operating pressure, by depressing the test button on the panel. This causes the lead pump to shut down, the lag pump to start, and the alarm to sound.

To shut off alarm and return to lead pump, move selector switch to *off*, then back to lead pump

position. If the test button is held down for approximately 15 seconds, the lag pump will also shut down. To shut off alarm and return to lead pump, move selector switch to *off* for approximately 15 seconds to allow timers to reset, then back to lead pump position.

CORRECT DISCHARGE LINE SIZE

The charts below can help determine suggested minimum supply line size for SPM Duplex Automatic models. Use of pipe or tubing which is too small can cause increased frictional losses resulting in inadequate system discharge pressure.

Refer to the correct chart for the particular size SPM unit being installed. Determine *Length of Horizontal*

SPM-15-DA

RECOMMENDED
DISCHARGE LINE
SIZE

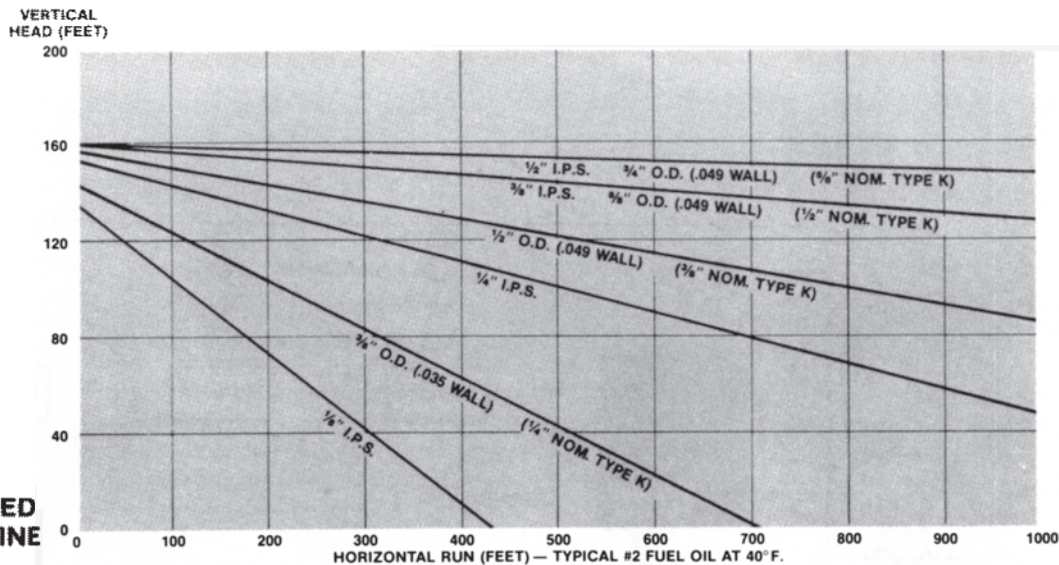

SPM-30-DA

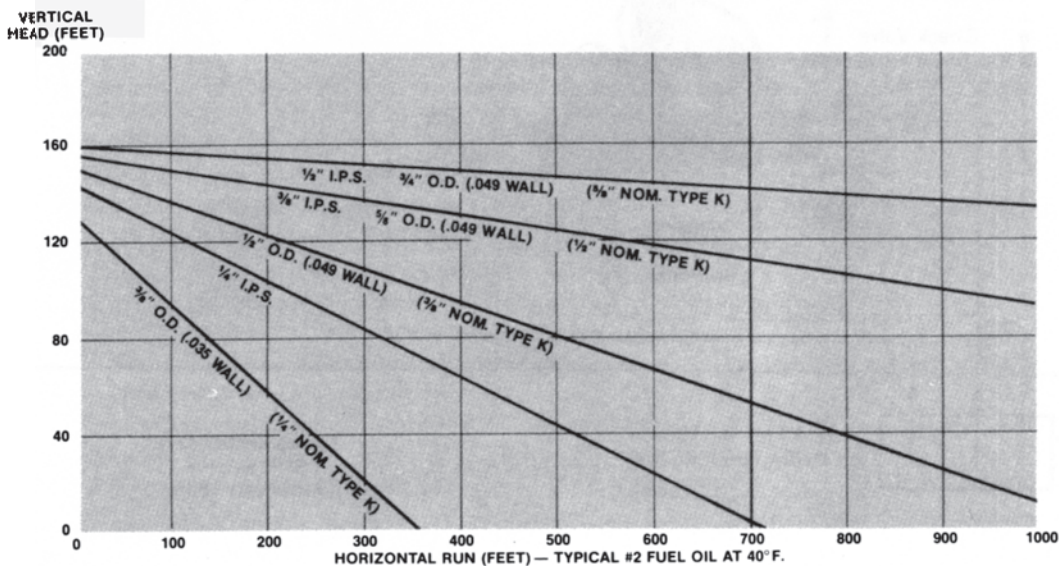

Charts represent maximum horizontal run vs. vertical head for Standard Schedule 40 iron or steel pipe (I.P.S.) and for Type K copper tubing, recommended for underground service. The actual O.D. and wall thickness are indicated for each tube size. (Note: The nominal size of Type K tubing is 1/8 inch smaller than actual O.D.)

Run - Feet measured to the highest, most remote burner and read up to Vertical Discharge Head - Feet measured to highest, most remote burner.

The determined point on the chart indicates the minimum diameter copper tubing or Schedule 40 standard pipe that can be used while still assuring that the SPM unit will deliver adequate system pressure. Use the pipe or tube size whose straight line passes above and closest to the intersection point.

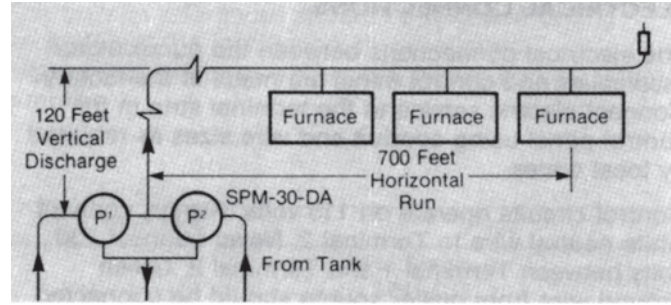

Example: System shown requires SPM-30-DA, has 120 feet vertical discharge head and 700 feet horizontal run. Refer to chart for SPM-30-DA and read up from 700 feet horizontal run to 120 feet vertical head. The closest lines that pass above this point are for 1/2 inch I.P.S. standard pipe; 3/4 inch O.D. copper tubing; or 5/8 inch Nom. Type K.

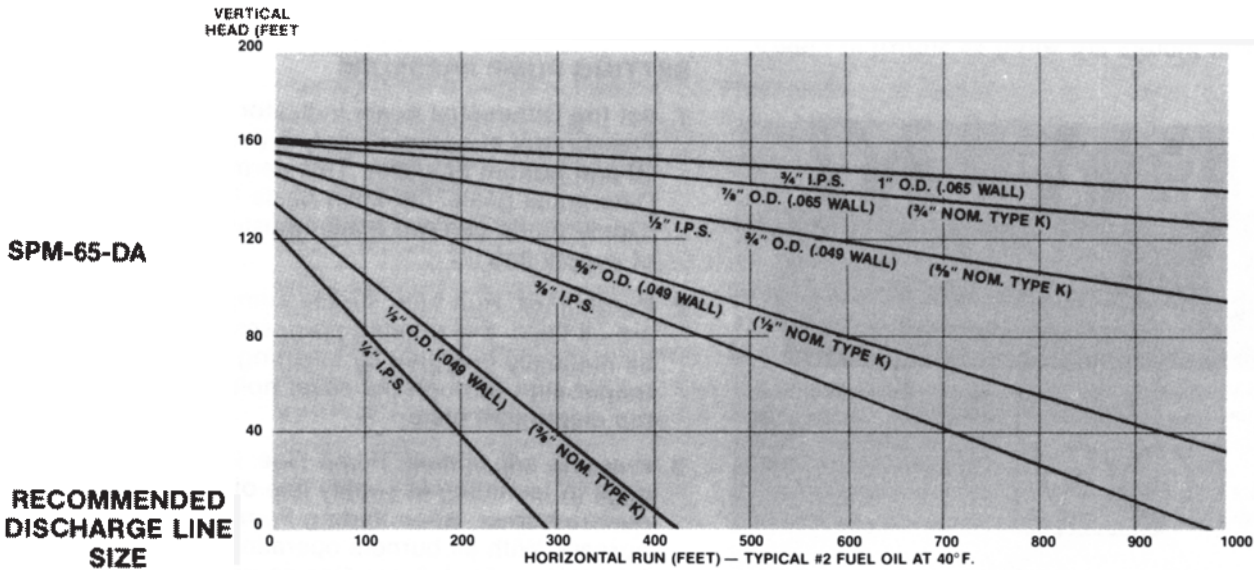

RECOMMENDED DISCHARGE LINE SIZE

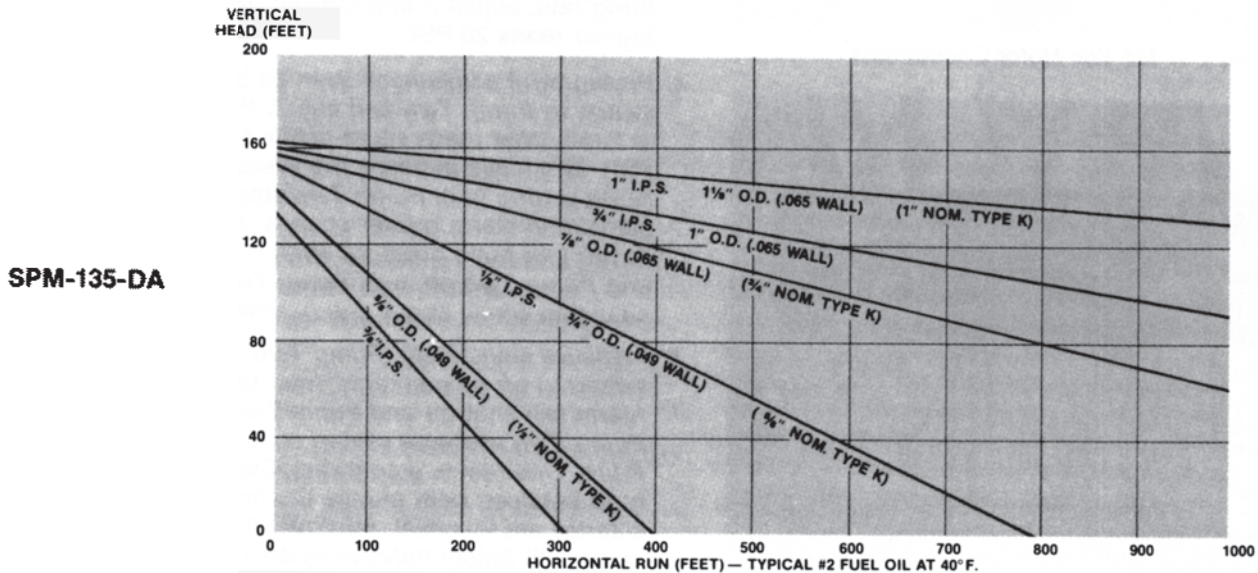

Charts represent maximum horizontal run vs. vertical head for Standard Schedule 40 iron or steel pipe (I.P.S.) and for Type K copper tubing, recommended for underground service. The actual O.D. and wall thickness are indicated for each tube size. (Note: The nominal size of Type K tubing is 1/8 inch smaller than actual O.D.)

SPM Duplex Automatic Models - continued

ELECTRICAL CONNECTIONS

The electrical connections between the pump/motor assemblies and control panel are made at the factory. Connect electric service to the terminal strip in the control panel using conduit and wire sizes as required by local codes.

Control circuits operate on 115 volts. Always connect white neutral wire to Terminal 2. Never connect 230 volts between Terminal L1 and Terminal 2. Green ground wire from power source should be connected to one of the panel mounting screws.

Important: SPM-135-DA motors are dual voltage and are prewired for 230 volts at factory. To operate on 115 volts, consult motor manufacturer's instructions accompanying unit for proper wiring.

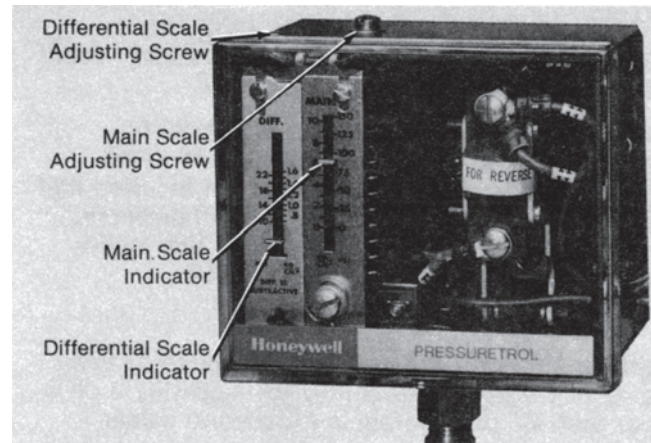
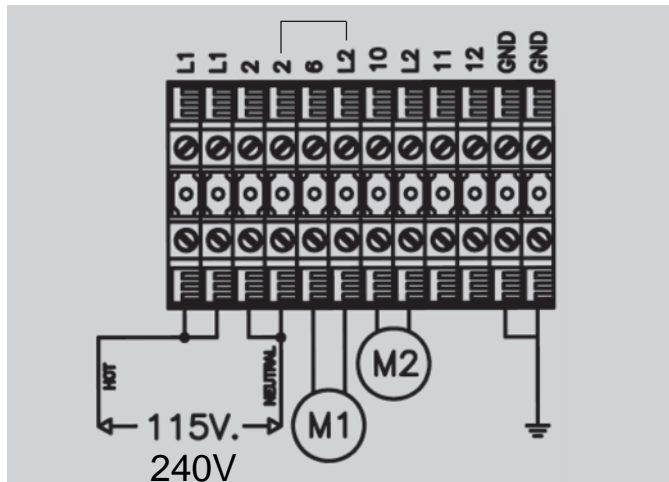

The adjusting screws on the Pressuretrol, located in the factory-wired control panel, should be set carefully according to instructions, below.

SETTING PUMP PRESSURE

1. Set the Differential Scale Indicator on the Pressuretrol at approximately 5 (half-way between 10 and bottom of scale). This permanently sets the Differential Scale. Set Main Scale Indicator at 0, so supply pump can run continuously during purging of supply line.
2. Purge lines. Run both supply pumps to assure both are oil filled. For priming purposes, OSV valves can be manually operated by inserting a stiff wire (paper clip) through the cover hole, and depressing the diaphragm plate.
3. Pressure adjustment, *Pump One*: Install compound gage in tee fitting in supply line of highest or most remote burner. After starting *Pump One*, start all burners. With all burners operating at maximum firing rate, adjust *Pump One* so gage at remote burner reads 20 PSI.
4. Pressuretrol adjustment: With all burners firing, switch to *Pump Two* and adjust *Pump Two* so gage at last burner reads slight positive pressure (2-5 PSI). Gradually increase the Pressuretrol Main Scale setting until *Pump Two* stops, *Pump One* starts, and alarm buzzer sounds. Allow *Pump One* to run and build pressure. With *Pump One* running and *Pump Two* off, turn *Pump Two* pressure adjusting screw about one-quarter turn clockwise.
5. Pressure adjustment, *Pump Two*: Move selector switch to *off* momentarily, then back to *Pump Two*. Alarm will shut off and *Pump Two* will start. Adjust *Pump Two* pressure setting so it is the same as *Pump One* (set in step three). Switch back and forth between both pumps to confirm pressure settings are identical. Shut off all burners. Pressure at any Oil Safety Valve in system must not exceed maximum operating pressure of 60 PSI, when supply pump is running and all burners are off.

Webster®

Fuel Pumps & Valves

A Division of Capital City Tool, Inc.
 219 Hahn Drive
 Frankfort, Ky. 40601
 www.websterfuelpumps.com

Webster Duplex Fuel Oil Pump Sets

Webster has the ability to offer pump sets in a variety of combinations. Webster will mount any of our low speed pump heads to any AC motor and panel type. Duplex Automatic and Duplex Manual configurations.

Standard Duplex Operation and Features.

The SPM duplex models consist of two pump/motor assemblies with a pre-piped, common discharge manifold. One pump/motor unit operates continuously, with the second providing backup service if the main pump fails. Either automatic (SPM-DA models) or manual (SPM-DM models) controls are available.

The duplex automatic series are designed specifically for buildings where a constant supply of oil must be assured... hospitals, apartment buildings, schools and other commercial/ Industrial buildings.

The DA Series is equipped with a pressure sensing device which detects a loss in pressure of the primary pump. If the standby pump is brought into service, an alarm sounds which indicates a malfunction in the primary pump.

The electric control circuit on the duplex automatic pump set is equipped with a lead-lag to permit alternation of pump to provide even wear on each pump.

The manually operated duplex pump sets offer the same protection as an automatic except the standby pump must be turned on manually which requires that maintenance personnel always be available.

Standard SPM Duplex Pump Sets

(Models SPM-15, SPM-30, SPM-65 and SPM-135)

Selection Table		Standard SPM Series Duplex Automatic Supply Pumps						
Models and Design Data Table								
Model	Type	Motor Voltage	Phase	Motor HP	Max Head	Valve Adjustment Range	Max Flow @ 10 psi	Max Flow @ 100 psi
SPM-15-1-DA	Duplex Auto	115	Single	1/6	200'	10 to 100 psi	22	15
SPM-15-2-DA	Duplex Auto	230	Single	1/3	200'	10 to 100 psi	22	15
SPM-33BT2R181-DA	Duplex Auto	230/460	Three	1/3	200'	10 to 100 psi	22	15
SPM-30-1-DA	Duplex Auto	115	Single	1/4	200'	10 to 100 psi	45	30
SPM-30-2-DA	Duplex Auto	230	Single	1/3	200'	10 to 100 psi	45	30
SPM-33BT2R283-DA	Duplex Auto	230/460	Three	1/3	200'	10 to 100 psi	45	30
SPM-65-1-DA	Duplex Auto	115	Single	1/3	200'	10 to 100 psi	90	65
SPM-65-2-DA	Duplex Auto	230	Single	1/3	200'	10 to 100 psi	90	65
SPM-33BT2R686-DA	Duplex Auto	230/460	Three	1/3	200'	10 to 100 psi	90	65
SPM-135-DA	Duplex Auto	115/230	Single	1/2	200'	10 to 100 psi	157	135
SPM-50BT2V086-DA	Duplex Auto	230/460	Three	1/2	200'	10 to 100 psi	157	135
The Above pumps are set at 20 psi								

The Standard Duplex Panel is also available for our SPMB and SPMV pump sets.

Our Standard Duplex Automatic Fuel Oil Transfer Pumps are available with the following.

- Flow rates from 15 GPH up to 135 GPH
- Discharge pressures from 10-100 psig
- 1725 rpm Direct Drive Motors
- Two Pump and Motor assemblies
- Duplex Automatic Panel with Automatic Switch Over
- One Hand-Off-Auto switch
- One Lead Lag Pump Switch
- Two "Pump On" indicator lights
- Duplex panel Test Button
- Alarm with Indicator Light
- One Reset Circuit Breaker
- Two Magnetic Motor Starters with Overload Protection
- One Compound Gauge on discharge block
- One Discharge connection

Dimensions

Model	A	B	C	D
SPM-15	6.88	15.50	—	—
SPM-30	7.44	16.13	—	—
SPM-65	8.96	19.50	—	—
SPM-135	10.94	21.70	* 7.75	* 21.70

*SPM-135 3 PHASE

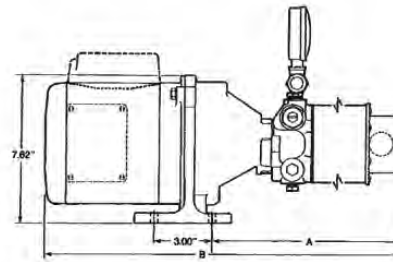
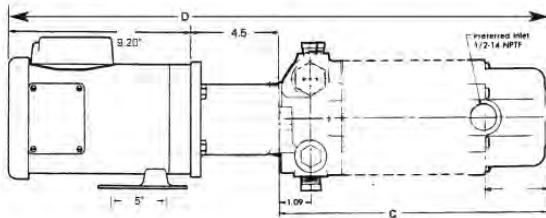

Dimensions Duplex Automatic

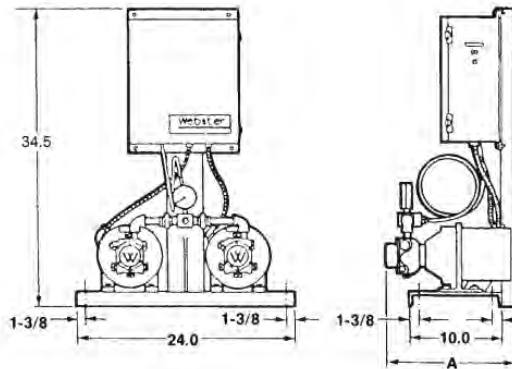

Model	A	Pipe Tap
SPM-15-DA	14.94	1/4
SPM-30-DA	16.53	1/4
SPM-65-DA	16.90	1/4
SPM-135-DA	21.37	3/8

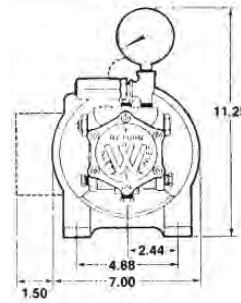

Dimensions Duplex Manual

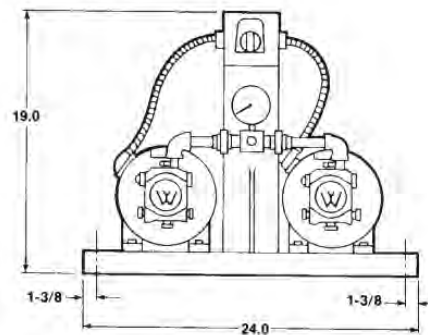

Model	A	Pipe Tap
SPM-15-DM	14.94	1/4
SPM-30-DM	16.53	1/4
SPM-65-DM	16.90	1/4
SPM-135-DM	21.37	3/8

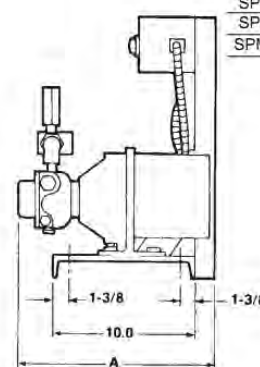

Section Four: Installation Checklist

This checklist is a general review of instructions which are vital to trouble-free operation of SPM supply units. Each item should be given serious consideration during planning and installation of the supply system.

The bulletin references should be reviewed during each step of the installation. If you suspect mechanical failure of equipment, please contact your supplier.

Problem	Installation Checklist	Reference	Page	
			SPM Single & SPM-DM	SPM-DA
Supply unit does not run	Check motor electrical connections	"Electrical Connections"	8	14
	Check for obstruction in return line (such as reversed check valve)	—	—	—
	Check circuit breaker and correct possible overload	—	—	—
Unit runs, but no oil reaches supply pump	Measure suction inlet vacuum	"Measuring Inlet Vacuum"	4	4
	Check that all plugs and suction line connections are air tight	"Tank to Pump Connections"	5	10
	Be certain by-pass plug is in position	Photograph	5	5
	Use adequate size suction line	"Correct Suction Line Size"	2	2
	Be certain suction line filter or strainer has adequate capacity	"Filter or Strainer"	2	2
	Install low pressure drop, swing type check valves in suction line	"Tank to Pump Connections"	5	10
Unit supplies oil to distribution system, but no delivery of oil at OSV valves	Confirm specified unit can provide needed vertical discharge pressure	"Correct Supply Line Size"	6	12
	Check that all supply line connections are air and oil tight	"Distribution Piping"	4	4
	Use adequate size supply line	"Correct Supply Line Size"	6	12
	Minimize supply line restrictions	"Distribution Piping"	4	4
	Prime pump and purge supply lines of air	"Setting Pump Pressure"	8	14
	Check pump pressure setting	"Setting Pump Pressure"	8	14
Oil delivery at OSV valves, but burners do not fire	Confirm specified unit can provide needed capacity	"Specifications-Design Data"	5	10
	In pressurized system, adjust pressure to develop reading of 10-15 PSI at most remote or highest burner	"Setting Pump Pressure"	8	14
	In open loop system, install standpipe, back pressure valve or over-sized drop pipe	"Open Loop Supply Systems"	8	—
	Check for leaking or damaged OSVs	—	—	—
	Check for line failure between OSVs and burner pumps	—	—	—
	Check burner for fuel pump failure or ignition problems	—	—	—
Burner pump seal damage	Install OSVs to assure pressure at burner pumps does not exceed 3 PSI	"Oil Safety Valves"	4	4
	Check to assure that pressures at OSVs do not exceed maximum of 60 PSI	"Setting Pump Pressure"	8	14
	Install pressure relief valve if entrapment condition is detected	"Entrapment Condition"	4	4
	In multi-level systems, check vertical distance between lowest OSV valve and highest point in the piping	"Multi-Level Supply Systems"	7	7

NOTES



Webster, Inc. warrants that Heating Products shall be free from defects in materials and workmanship for a period of two (2) years from the date of manufacture, or one (1) year from the date of installation, whichever period expires first. Webster will rebuild or replace, at its option, all Heating Products proven to its satisfaction to be defective within such warranty period and returned to the Webster factory, transportation charges prepaid. Webster's sole obligation and buyer's exclusive remedy hereunder is limited to such rebuilding or replacement.

No products may be returned to the Webster factory unless the prior written consent for said return shall have been obtained from the Heating Products Customer Service Department in Frankfort, Kentucky. This Limited Warranty does not cover shipping costs to and from the Webster factory, any costs for labor or otherwise related to product removal or replacement, or any other costs of any nature without prior written consent by Webster.

Parts, products and accessories made by others are warranted only to the extent of the original manufacturer's warranty to Webster.

This warranty shall not apply to acts of God, war or civil insurrection, nor shall it apply to products which, in the sole judgment of Webster, have been subject to negligence, abuse, accident, misapplication, tampering, alteration; nor due to other than normal application, use or service, including but not limited to, operational failures caused by corrosion, rust or other foreign materials in the system, or operation at pressures in excess of recommended maximums.

Purchaser shall be solely responsible for determining suitability for use of Webster Heating Products. Webster shall not in any event whatsoever, have any liability with respect to such determinations.

THE FOREGOING WARRANTY IS EXCLUSIVE AND IN LIEU OF ALL OTHER WARRANTIES, EXPRESS OR IMPLIED, INCLUDING BUT NOT LIMITED TO THE IMPLIED WARRANTIES OF MERCHANTABILITY AND FITNESS FOR A PARTICULAR PURPOSE. WEBSTER SHALL NOT BE LIABLE FOR ANY CONSEQUENTIAL, INCIDENTAL OR CONTINGENT DAMAGES WHATSOEVER.

NOTE TO CONSUMERS: THIS LIMITED WARRANTY IS EXTENDED TO THE COMMERCIAL CUSTOMERS, DEALERS AND INSTALLERS OF WEBSTER ONLY. THE SUPPLIER/INSTALLER WILL EXTEND WARRANTY COVERAGE TO YOU WHICH COVERS WEBSTER'S PRODUCTS. WEBSTER'S WARRANTY TO SUCH CUSTOMERS, DEALERS AND INSTALLERS WILL BACK UP THE WARRANTY EXTENDED TO THE CONSUMER.
